

Blendenmaße

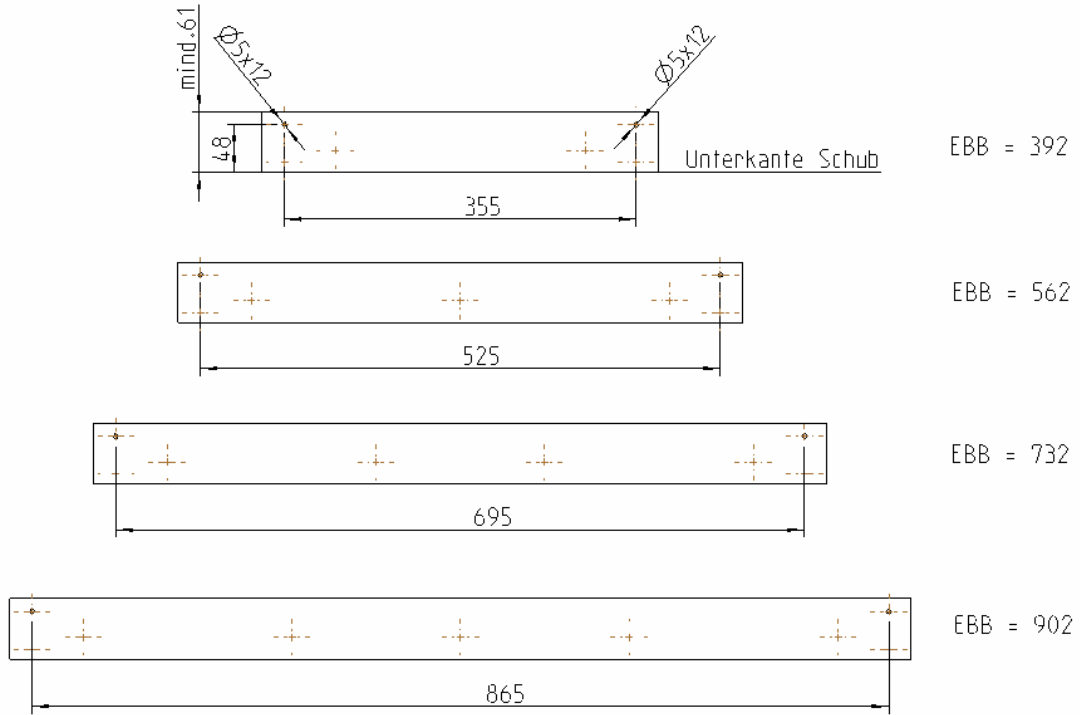

Bohrmaße Seitenwand

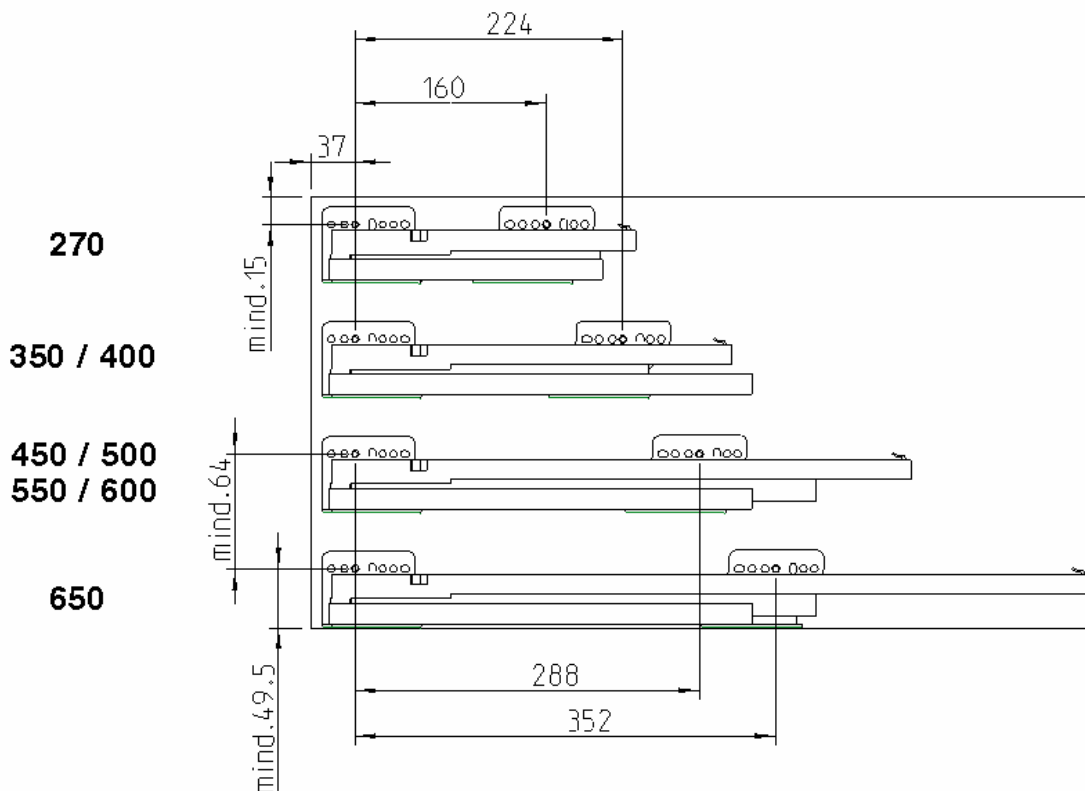

Bohrmaße Blende mit Reling

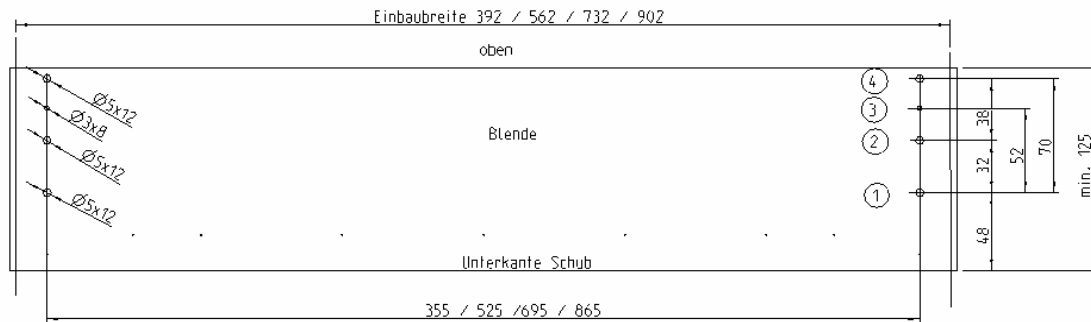

- ① für Schubbefestigung mit Minifixbolzen
- ③ für Blendenstütze 701.49.291
- ②④ für Reling mit 2 Stangen
- ④ für Reling mit einer Stange

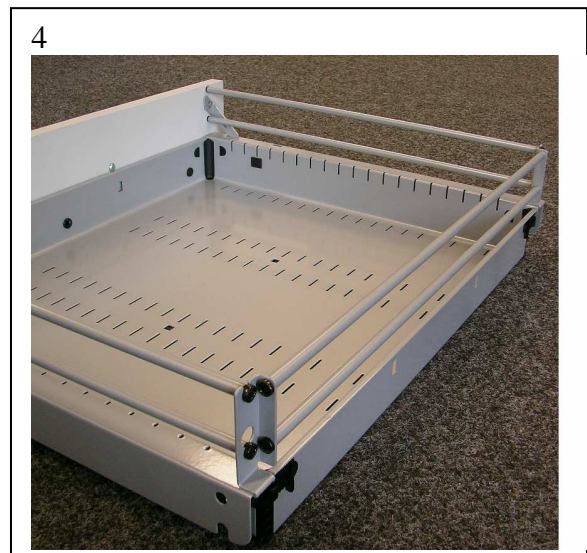
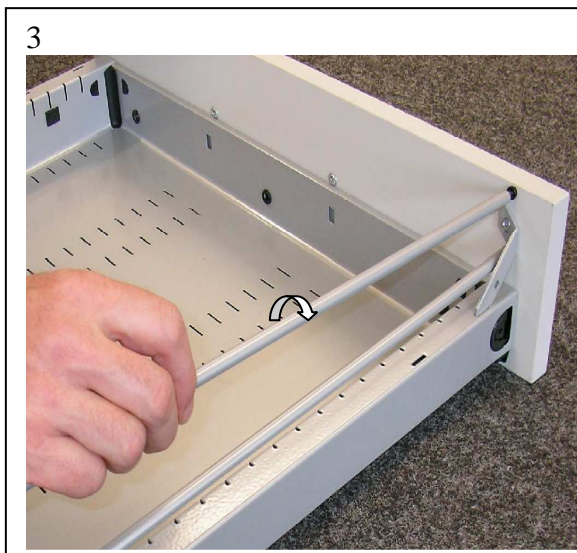
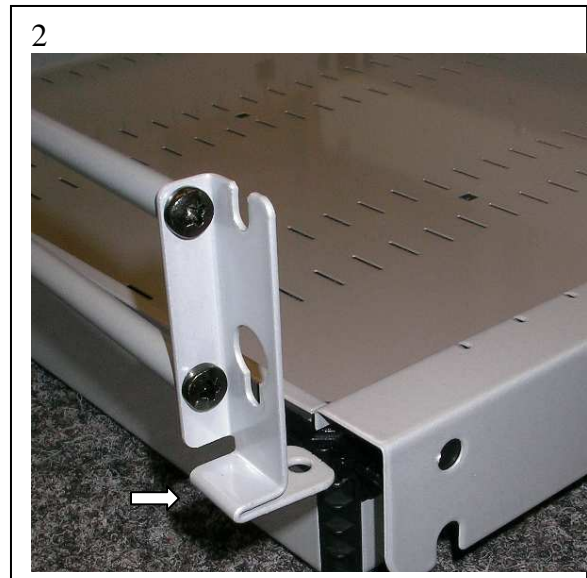
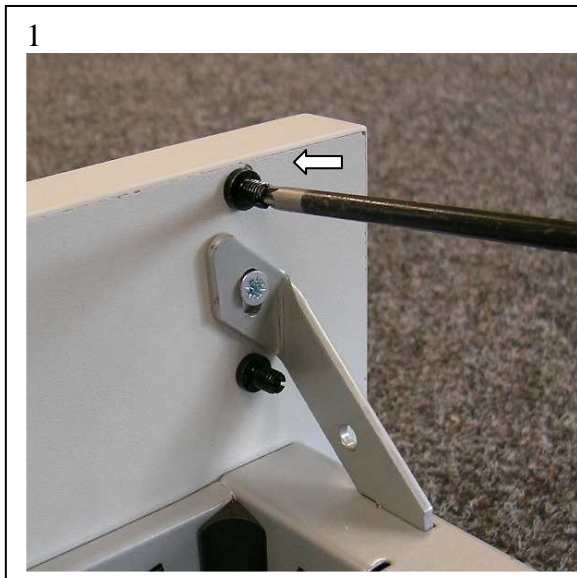

U7014721250045

Einbau Schließsystem

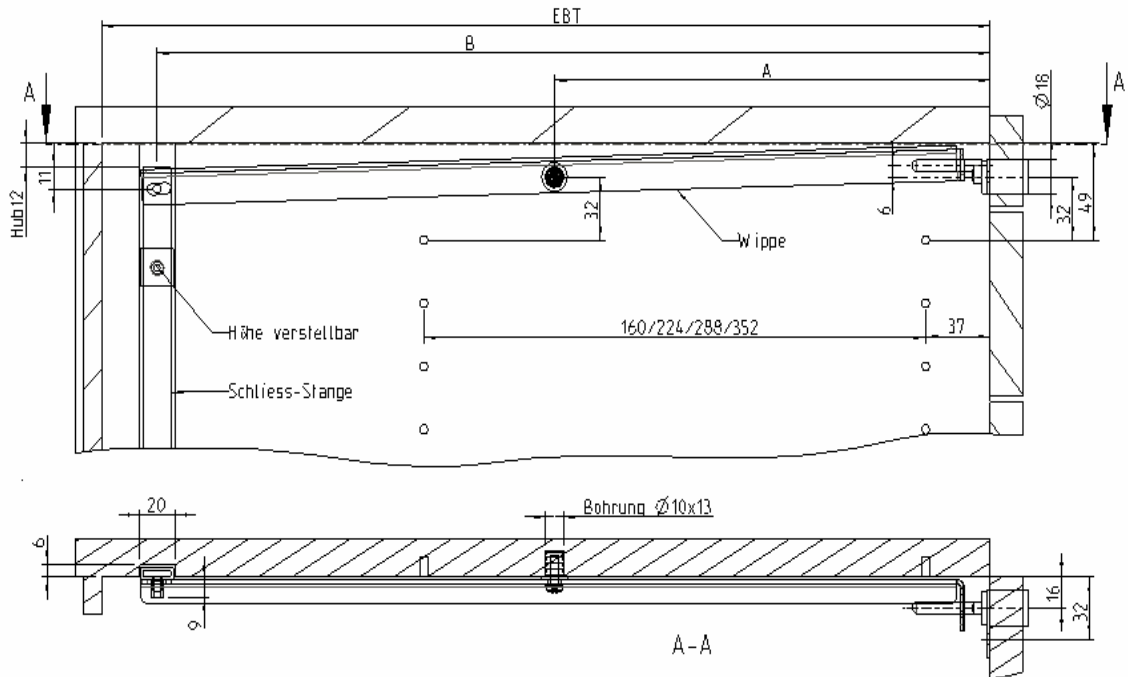

Nenntiefe	EBT	A	B
270	275	135	248
350	355	175	328
400	405	200	378
450	455	225	428
500	505	250	478
550	555	275	528
600	605	300	578
650	655	325	628

Schließsystem rechts

